

T-10 Meter

Sizes: 5/8", 3/4", and 1"

T-10 water meters are warranted for performance, materials, and workmanship.



Every T-10 water meter meets or exceeds the latest AWWA C700 Standard. Its nutating disc, positive displacement principle is time proven for accuracy and dependability since 1892, ensuring maximum utility revenue.

Construction

The T-10 water meter consists of three major assemblies: a register, an EnviroBrass™ II maincase, and a nutating disc measuring chamber.

The T-10 meter is available with a variety of register types. For reading convenience, the register can be mounted in one of four positions on the meter.

The corrosion-resistant EnviroBrass II maincase will withstand most service conditions: internal water pressure, rough handling, and in-line piping stress.

The innovative floating chamber design of the nutating disc measuring element protects

the chamber from frost damage while the unique chamber seal extends the low flow accuracy by sealing the chamber outlet port to the maincase outlet port. The nutating disc measuring element utilizes corrosion-resistant materials throughout and a thrust roller to minimize wear.

Warranty

Neptune provides a limited warranty with respect to its T-10 water meters for performance, materials and workmanship.

When desired, maintenance is easily accomplished either by replacement of major assemblies or individual components.

Systems Compatibility

Adaptability to all present and future systems for flexibility is available only with Neptune's ARB® Utility Management Systems™.

Key Features

■ Register

- Magnetic drive, low torque registration ensures accuracy
- Impact-resistant register
- High resolution, low flow leak detection
- Bayonet style register mount allows in-line serviceability
- Tamperproof seal pin deters theft
- Date of manufacture, size, and model stamped on dial face

■ EnviroBrass II Maincase

- Made from EnviroBrass II
- ANSI/NSF 61 Certified
- Lifetime guarantee
- Resists internal pressure stresses and external damage
- Handles in-line piping variations and stresses
- EnviroBrass II provides residual value vs. plastic
- Electrical grounding continuity

■ Nutating Disc Measuring Chamber

- Positive displacement
- Widest effective flow range for maximum revenue
- Proprietary polymer materials maximize long term accuracy
- Floating chamber design is unaffected by meter position or in-line piping stresses

T-10 Meter

Sizes: 5/8", 3/4", and 1"

5/8" Accuracy

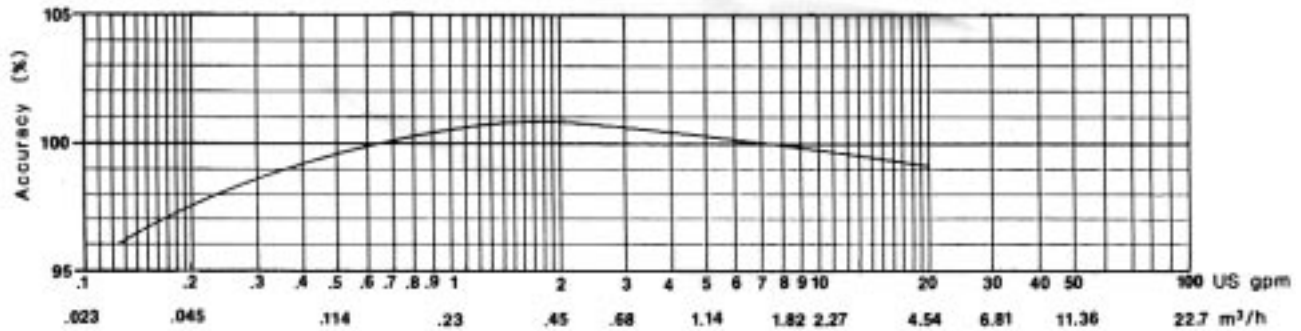

3/4" Accuracy

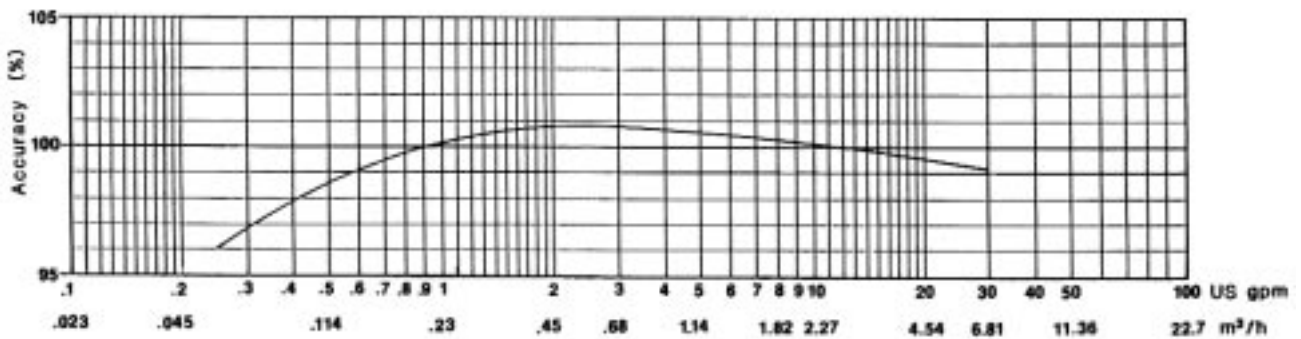

1" Accuracy

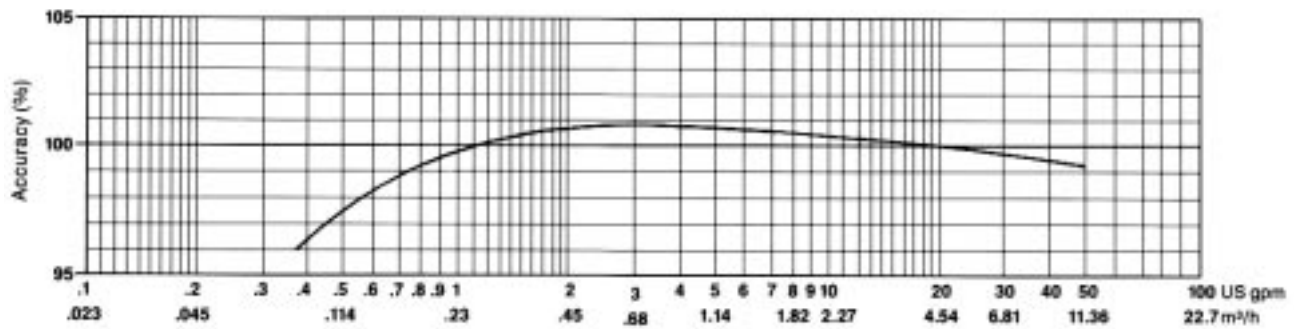

5/8" Pressure Loss

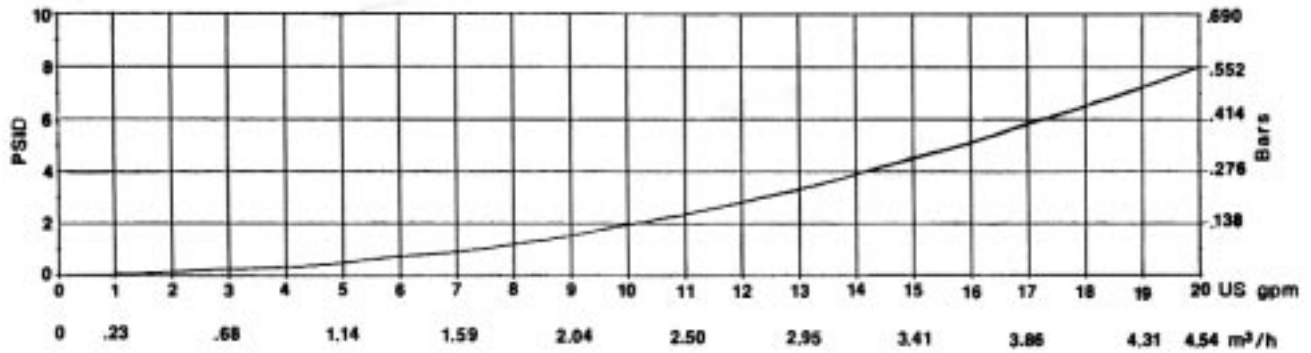

3/4" Pressure Loss

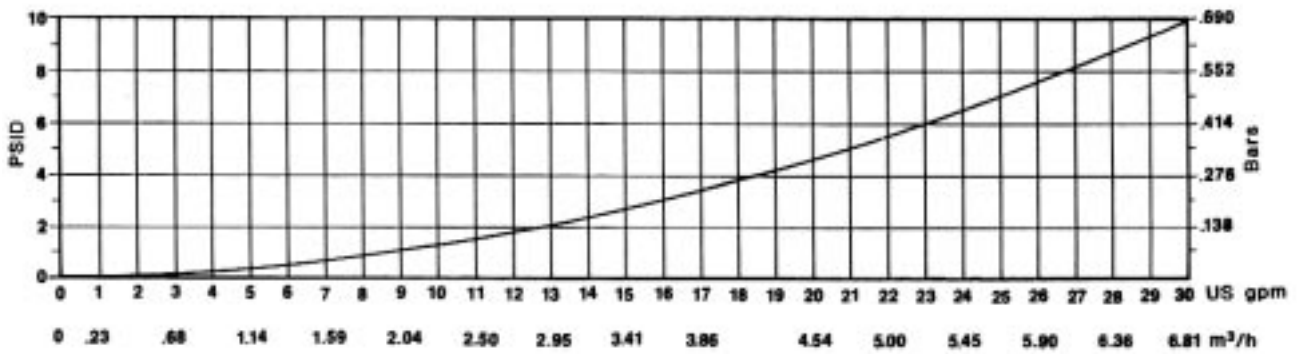

1" Pressure Loss

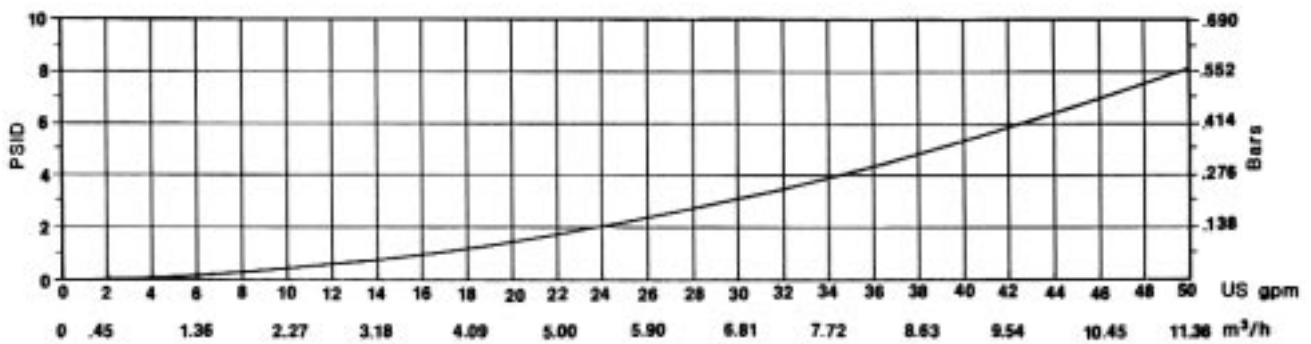

These charts show typical meter performance. Individual results may vary.

Operating Characteristics

Meter Size	Normal Operating Range @100% Accuracy (±1.5%)	AWWA Standard	Low Flow @ 95% Accuracy
5/8"	1/2 to 20 US gpm 0.11 to 4.55 m ³ /h	1 to 20 US gpm 0.23 to 4.5 m ³ /h	1/8 US gpm 0.03 m ³ /h
3/4"	3/4 to 30 US gpm 0.17 to 6.82 m ³ /h	2 to 30 US gpm 0.45 to 6.8 m ³ /h	1/4 US gpm 0.06 m ³ /h
1"	1 to 50 US gpm 0.23 to 11.36 m ³ /h	3 to 50 US gpm 0.68 to 11.4 m ³ /h	3/8 US gpm 0.09 m ³ /h

Registration Charts

ProRead Registration (per sweep hand revolution)	5/8"	3/4" & 1"
10 US Gallons	✓	✓
10 Imperial Gallons	✓	✓
1 Cubic Foot	✓	✓
0.1 Cubic Metre	✓	✓
0.01 Cubic Metre	✓	

E-Coder High Resolution (8-digit reading)	5/8"	3/4" & 1"
0.1 US Gallons	✓	✓
0.1 Imperial Gallons	✓	✓
0.01 Cubic Feet	✓	✓
0.001 Cubic Metres	✓	✓

Register Capacity ProRead & E-Coder	5/8"	3/4" & 1"
10,000,000 US Gallons	✓	✓
10,000,000 Imperial Gallons	✓	✓
1,000,000 Cubic Feet	✓	✓
100,000 Cubic Metres	✓	✓
10,000 Cubic Metres	✓	

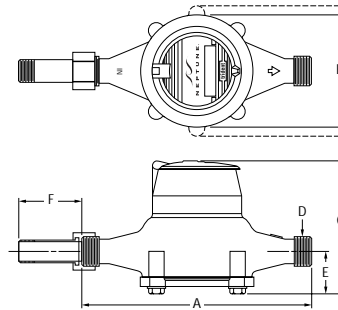

Dimensions

Meter Size	A in/mm	B in/mm	C-Std. in/mm	C-ARB in/mm	D-Threads per inch	D-OD in/mm	E in/mm	F in/mm	Weight lbs/kg
5/8"	7 1/2 191	3 5/8 92	4 7/8 124	5 3/8 137	14	1.030 26	1 5/8 41	2 1/2 64	3 3/4 1.7
5/8"x3/4"	7 1/2 191	3 5/8 92	4 7/8 124	5 3/8 137	11 1/2	1.290 33	1 5/8 41	2 5/8 67	4 1.8
3/4"	9 229	4 3/8 111	5 1/2 140	5 13/16 148	11 1/2	1.290 33	1 7/8 48	2 5/8 67	6 2.7
3/4"SL	7 1/2 191	4 3/8 111	5 1/2 140	5 13/16 148	11 1/2	1.290 33	1 7/8 48	2 5/8 67	5 1/2 2.5
3/4"x1"	9 229	4 3/8 111	5 1/2 140	5 13/16 148	11 1/2	1.626 41	1 7/8 48	2 3/4 70	6 1/2 2.9
1"	10 3/4 273	6 1/2 165	6 3/8 162	6 5/8 168	11 1/2	1.626 41	2 1/8 54	2 3/4 70	9 3/4 4.4
1"x1 1/4"	10 3/4 273	6 1/2 165	6 3/8 162	6 5/8 168	11 1/2	1.865 47	2 1/8 54	2 13/16 71	10 1/4 4.6

Guaranteed Systems Compatibility

All T-10 water meters are guaranteed adaptable to our ARB®V, ProRead (ARB VI) AutoDetect, E-Coder™ (ARB VII), TRICON®/S, TRICON/E3®, and Neptune meter reading systems without removing the meter from service.

Specifications

- Certification: ANSI/NSF 61
- Application: cold water measurement of flow in one direction
- Maximum operating water pressure: 150 psi (1034 kPa)
- Maximum operating water temperature: 80°F
- Measuring chamber: nutating disc technology design made from proprietary synthetic polymer

Options

- Sizes:
 - 5/8", 5/8" x 3/4"
 - 3/4", 3/4" SL, 3/4" x 1"
 - 1", 1" x 1 1/4"
- Units of measure: U.S. gallons, imperial gallons, cubic feet, cubic metres
- Register types:
 - Direct reading: Bronze box and cover (standard)
 - Remote reading: ProRead Encoder, E-Coder™, TRICON/S, TRICON/E3
 - Reclaim
- Bottom caps:
 - Synthetic polymer (5/8" only)
 - Cast iron
 - EnviroBrass II, ductile iron
- Connections: EnviroBrass II, straight or bent
- Environmental Conditions:
 - Operating temperature: 33°F to 149°F (0°C to 65°C)
 - Storage temperature: 33°F to 158°F (0°C to 70°C)



www.neptunetg.com

Neptune Technology Group Inc.
1600 Alabama Highway 229
Tallahassee, AL 36078, USA
Tel: (800) 645-1892
Fax: (334) 283-7299

Neptune Technology Group (Canada) Ltd.
7275 West Credit Avenue
Mississauga, Ontario
L5N 5M9
Canada
Tel: (905) 858-4211
Fax: (905) 858-0428

Neptune Technology Group Inc.
Ejército Nacional No. 418
Piso 12, Desp. 1201-1202
Col. Chapultepec Morales
Delegación Miguel Hidalgo
11570 México, Distrito Federal
Tel: (525) 55203 5294 / (525) 55203 5708
Fax: (525) 55203 6503

PS T10SMALL 08.04
© Copyright 2004, Neptune Technology Group Inc.
ARB and TRICON are registered trademarks of Neptune Technology Group Inc. EnviroBrass is a registered trademark of Asarco Specialty Products.